



9 Watt LD9Wxxx –TL Series

CONSTANT CURRENT TRIAC/ELV DIMMABLE LED DRIVERS

Model: LD9W –TL Series

- Designed for use with Triac or ELV Phase Dimmers 120Vac or 230Vac/240Vac.
- 120Vac Version can be used without dimmer 120/208-277Vac
- Drive Mode: PFC Corrected
- Output Power: 20W Max.
- Input Voltage: 120 or 208-277VAC, 50/60Hz
- Number of Outputs: One
- Output Voltages: 7VDC - 36VDC
- Output Currents: 250mA - 750mA

Environmental

1. Operating temperature: Tc 90C Maximum. Reference -30 to +60°C ambient
2. Storage temperature range: -40 to +85°C
3. Humidity (non-condensing): 5% - 95%RH
4. Cooling: Convection
5. Vibration Frequency: 5-55Hz/2g, 30 minutes
6. Impact resistance: 1g/s
7. MTBF@ 40°C: 402,000 hours @ Full Load per MIL-217F Notice 2.

Safety and Compliance

1. UL8750, EN61347, CSA 22.2 safety recognized, UL Type HL
2. FCC, 47CFR Part 15 Class B compliant
3. Water resistant and Dust Proof Design: IP66, NEMA4, for Dry, Damp, Wet Locations.
4. Small compact plastic case.
5. Safety Isolation between Primary and Secondary
6. Meets EN61000-3-2 & EN61000-3-3 Class C
7. Protection: output over-voltage, output over-current, output short circuit, auto-recovery.
8. EN614000-4-5: 2kV surge protection.

Electrical Specifications at 25°C

- Input Voltage: 120Vac or 230Vac (208-277Vac)
- Frequency: 50/60HZ
- Power Factor: ≥ 0.90 Full Range no dimmer.
- THD: $\leq 20\%$ Full Range no dimmer
- Inrush current: $< 10A$ at 25C, 120Vac, cold start, Max. Load
- Input current: 0.10A at 120Vac, 60Hz, Maximum Load
- Efficiency: 84% typical at 120Vac, 60Hz
- Line regulation accuracy: $\pm 3\%$
- Load regulation accuracy: $\pm 5\%$
- Dimming Range: CCR Mode See Graph page 2.

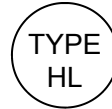

IP66



120VAC Constant Current Versions

Part Number ^(1,2)	US Class 2 Type HL	CN Class 2	Output Voltage Range	Output Constant Current	Current Accuracy	Output Power Maximum	Typical Efficiency ⁽³⁾	DIMMER ^(5,6)
LD9W120-36-C0250-TL	YES	YES	22 - 36 VDC	250 mA	$\pm 5\%$	9W	85%	Incan / ELV
LD9W120-30-C0300-TL	YES	YES	18 - 30 VDC	300 mA	$\pm 5\%$	9W	85%	Incan / ELV
LD9W120-28-C0350-TL	YES	YES	17 - 28 VDC	350 mA	$\pm 5\%$	9W	84%	Incan / ELV
LD9W120-20-C0450-TL	YES	YES	12 - 20 VDC	450 mA	$\pm 5\%$	9W	84%	Incan / ELV
LD9W120-14-C0700-TL	YES	YES	8 - 14 VDC	700 mA	$\pm 5\%$	9W	83%	Incan / ELV
LD9W120-12-C0750-TL	YES	YES	7 - 12 VDC	750 mA	$\pm 5\%$	9W	83%	Incan / ELV

208-277VAC Constant Current Versions

1. For 220/230/240/277Vac version Change Part designator to: LD9W230-XX-CXXXX-TL
2. LD9W120, 120Vac Version can be used without dimmer at 120Vac or 208-277Vac.

Notes

3. Typical efficiency for LD9W120 measured at 120Vac, LD9W230 measured at 230Vac input, full load, no dimmer.
4. All versions are $\sim \leq 15\%$ to $\sim 100\%$ CCR Dimmable with any good quality proper power phase dimmer. Refer to page 2
5. For LD9W120 use any good quality 120VAC $\leq 600W$ Incandescent (Triac) or ELV (Electronic Low Voltage) dimmer. Refer to page 2.
6. For LD9W230 use any good quality 230Vac $\leq 500W$ Incandescent (Triac) or ELV (Electronic Low Voltage) dimmer. Refer to page 2.
7. LD9W230 version will also work with 277Vac phase dimmers but loading must meet minimum requirements of dimmer being used.

9W

LD9Wxxx -TL

PHASE DIMMING



LED Optimized Drivers Triac & ELV Dimmable

9 Watt LD9Wxxx -TL Series CONSTANT CURRENT TRIAC/ELV DIMMABLE LED DRIVERS

Typical Dimming Curves:

%Output Current vs. Conduction Angle in Degrees

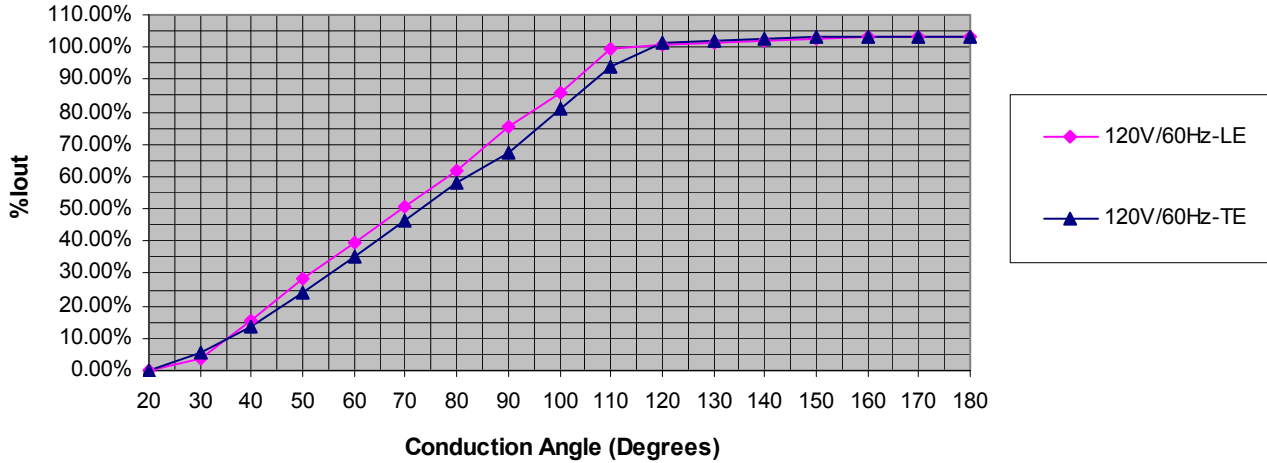

Mechanical Dimensions: Inches [mm]

Material: Black PC ABS Plastic Case
Fully Encapsulated
Weight: 128 grams (4.5 oz) Typical

Labeling Example

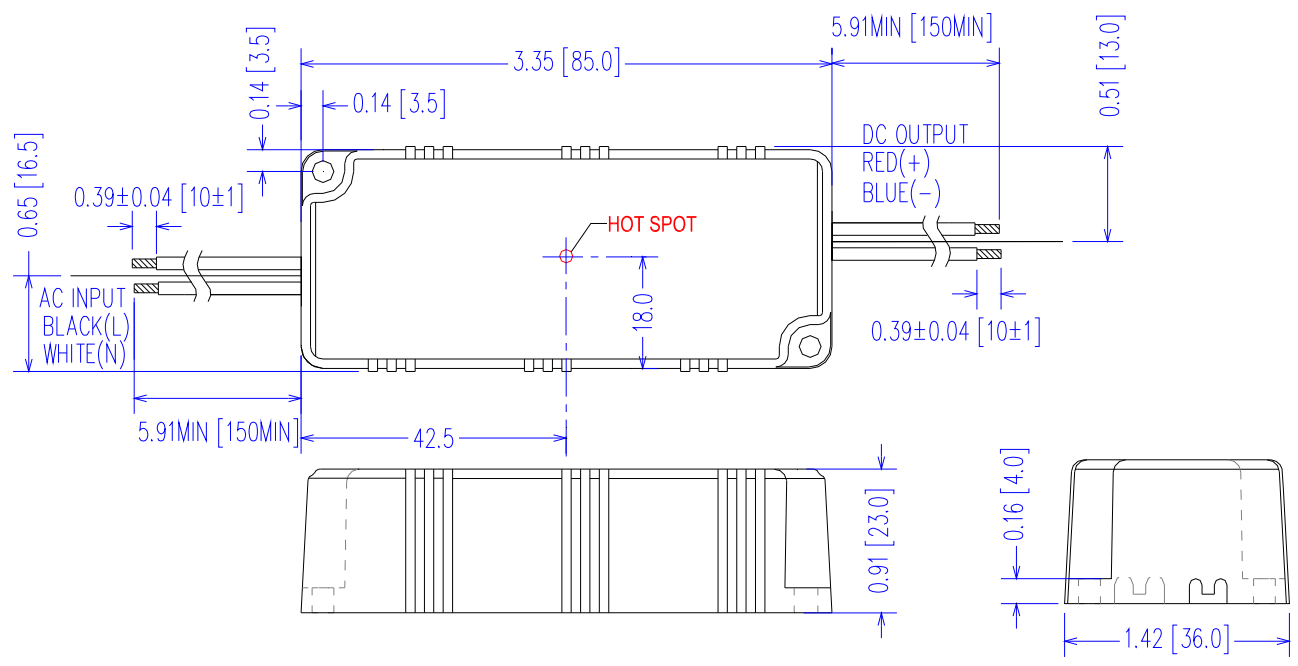

9 Watt LD9Wxxx -TL Series

CONSTANT CURRENT TRIAC/ELV DIMMABLE LED DRIVERS

Input Specifications

Parameter	Min.	Typ.	Max.	Notes/Conditions
Input Voltage	108 Vac	120 Vac	132 Vac	120 Vac Nominal Value Note: LD9W120, 120Vac Version can be used without dimmer at 120Vac or 208-277Vac
	208Vac	230Vac	300Vac	230Vac Nominal Value (220/230/240/277)
Input Frequency	47 Hz	—	63 Hz	50/60Hz Nominal
Input AC Current	—	—	0.10A	Measured at 120Vac/60Hz Input, Output Full load.
	—	—	0.06A	Measured at 230Vac/60Hz Input, Output Full load.
Inrush Current (Peak)	—	2A	10A	Measured at 277Vac/60Hz Input, Output Full Load, Ta 25°C, Cold Start 50% I _{peak} duration \approx 750 μ sec (1/2*I _p ² *t)
Inrush Current (I ² t)	—	—	0.038 A ² s	
Leakage Current	—	—	0.28mA	Measured at 120Vac/60Hz Input, Output Full load.
	—	—	0.75mA	Measured at 277Vac/60Hz Input, Output Full load.
THD	—	—	20%	Measured at 120 or 230Vac Input, Output \geq 60% Load, No Dimmer
Power Factor (PF)	0.90	—	—	Measured at 120 or 230Vac Input, Output \geq 60% Load, No Dimmer

Output Specifications

Parameter	Min.	Typ.	Max.	Notes/Conditions
DC Output Voltage	Per Table	—	Per Table	Per Tables on Page 1
DC Output Constant Current	-5%	Per Table	+5%	Per Tables on Page 1
Output Power	—	—	Per Table	Per Tables on Page 1
Ripple & Noise (V _{pk-pk})	—	—	10%	20 MHz BW, Full load output in parallel with 0.1 μ F ceramic & 10 μ F Electrolytic.
Ripple (I _{pk-pk})	—	—	60%	20 MHz BW, Full load output in parallel with 0.1 μ F ceramic & 10 μ F Electrolytic. 120 Hz component
Start-up Time	—	700 mS	1000 mS	Measured at 120Vac/60Hz Input, Output Full load.
Hold-up Time	—	30 mS	—	Typical @ 120/277Vac Input, Output Full load.

Environmental Specifications

Parameter	Min.	Typ.	Max.	Notes/Conditions
Case Temperature (T _c)	-30 °C	—	+90 °C	Measured at location specified on case.
Operating Temperature (T _a)	-30 °C	—	+60 °C	This is a reference range. T _c controls temperature range.
Storage Temperature (T _s)	-40 °C	—	+85 °C	Non operating temperature range.
Operating Humidity	—	—	95% RH	Relative Humidity, non-condensing.
Vibration	5 Hz	—	55 Hz	2G, 10 minutes/1 cycle, period 30 minutes, each along X, Y, Z axis.
MTBF	402,000 Hours	—	—	MIL-HDBK-217F Notice 2, T _a = 25C, Output Full Load.

Protection Specifications

Parameter	Min.	Typ.	Max.	Notes/Conditions
Output Short Circuit (SCP)	—	—	—	No Damage, Auto recovery after short is removed.
Output Over Current (OCP)	—	—	+8% I _o	Constant Current Limiting circuit.
Output Over Voltage (OVP)	—	—	120% V _o	No Damage, Auto recovery after fault is removed.

9W**LD9Wxxx -TL****PHASE DIMMING****LED Optimized Drivers
Triac & ELV Dimmable**

9 Watt LD9Wxxx -TL Series

CONSTANT CURRENT TRIAC/ELV DIMMABLE LED DRIVERS

Safety Compliance

Safety	Notes/Standards
UL/CUL	UL8750, UL1310 for UL Class 2 & CAN/CSA C22.2 No. 250.13, UL Type HL
CE	EN61347-1, EN61347-2-13
Withstand Voltage	Input to Output: 3750 Vac
Isolation Resistance	Input to Output: >100 MΩ, 500VDC @ 25 °C, 70 % RH
Dimming Circuit	AC Phase Dimmable. Incandescent Forward Phase or ELV reverse phase.

EMC Compliance

Standard	Notes/Conditions
FCC, 47CFR Part 15	Class B
EN 55015	Limits and methods of measurement of radio disturbance characteristics of electrical lighting and similar equipment.
EN 61000-3-2	Part 3-2: Limits for harmonic current emissions Class C, ≥80% Rated Power
EN 61000-3-3	Part 3-3: Limitation of voltage changes, voltage fluctuations and flicker.
EN 61000-4-5	Part 4-5: Surge Immunity test, 2 kV L-N, 4 kV L-FG & N-FG
Energy Star	Energy Star transient protection: Ballast or driver shall comply with ANSI/IEEE C62.41.1-2002 and ANSI/IEEE C62.41.2-2002, Category A operation. The line transient shall consist of seven strikes of a 100 kHz ring wave, 2.5 kV level, for both common mode and differential mode.

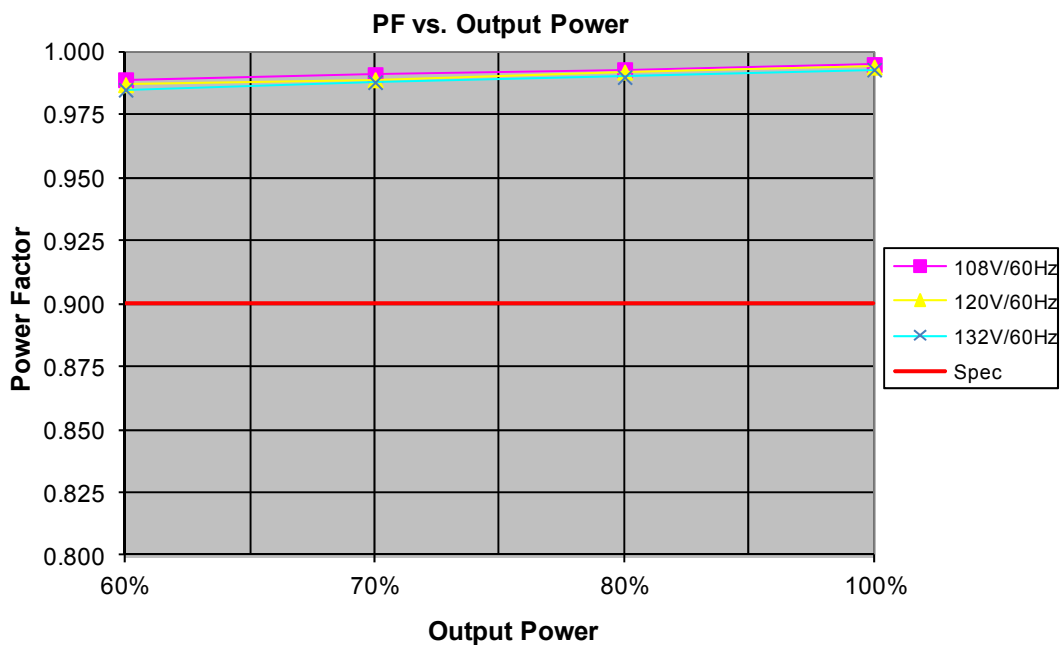
Power Factor Curves (Typical) - Direct Connect to AC (No Dimmer)

9 Watt LD9Wxxx -TL Series

CONSTANT CURRENT TRIAC/ELV DIMMABLE LED DRIVERS

THD Curves (Typical) - Direct Connect to AC (No Dimmer)

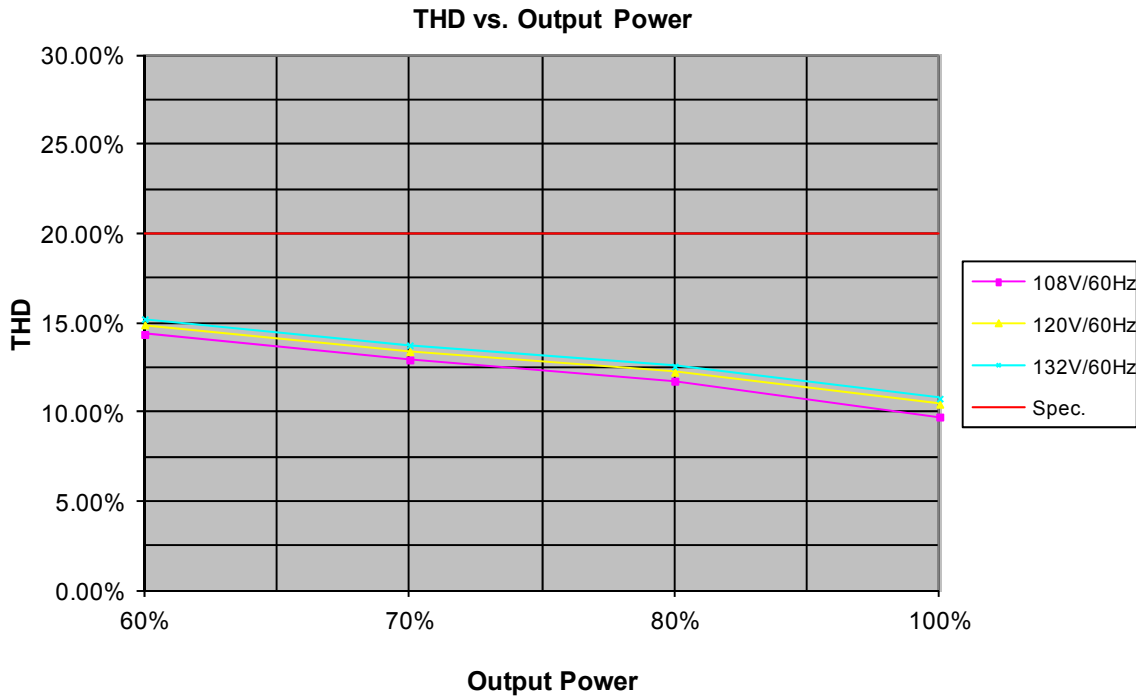

Efficiency Curve (Typical) LD9W120-28-C0350-TL

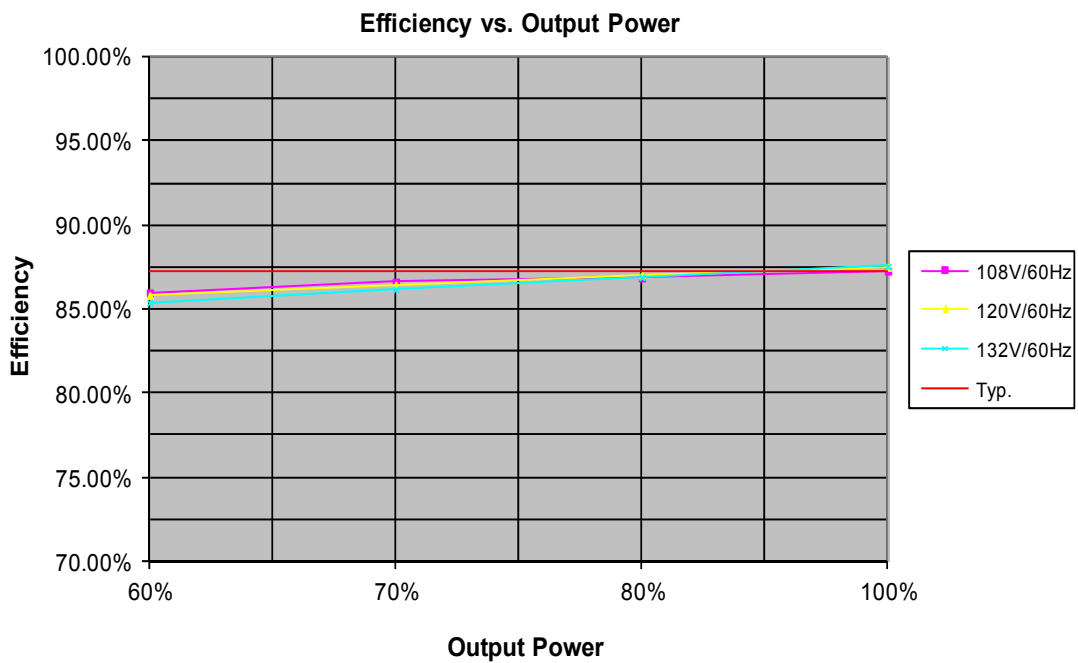

9W

LD9Wxxx -TL

PHASE DIMMING



LED Optimized Drivers
Triac & ELV Dimmable

9 Watt LD9Wxxx -TL Series

CONSTANT CURRENT TRIAC/ELV DIMMABLE LED DRIVERS

Life vs. Ambient Temperature

LD9W Estimated Life Full Load @ 120Vac

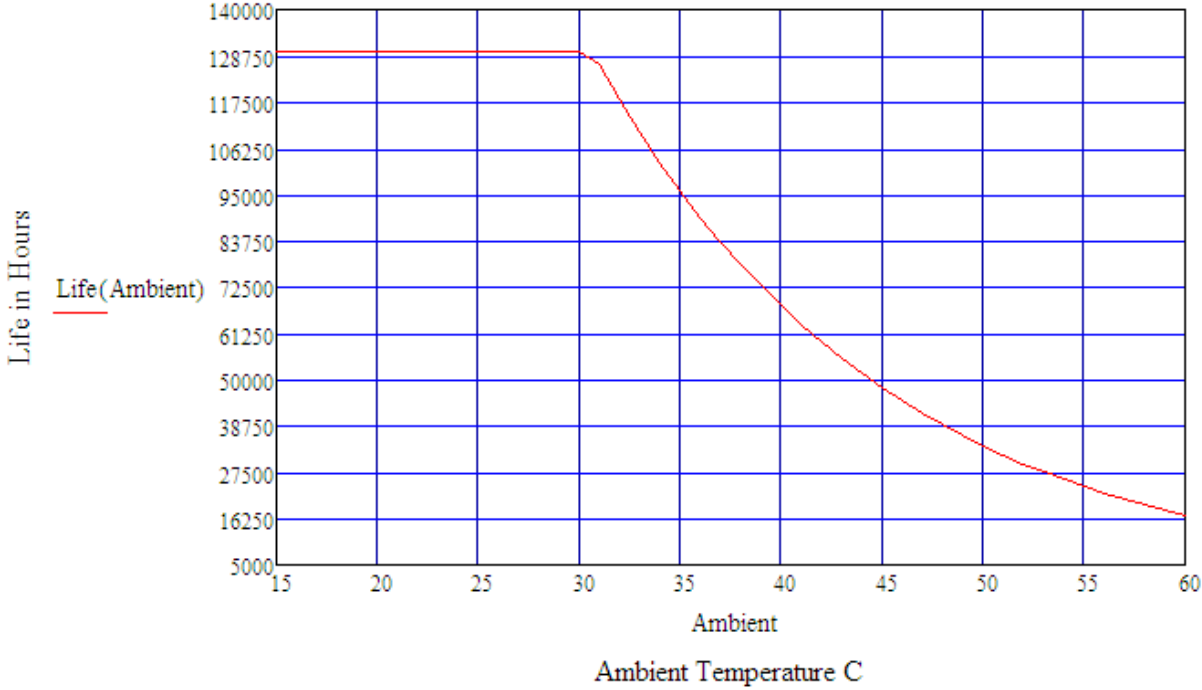

Life vs. Case (Tc) Temperature

LD9W Estimated Life Full Load @ 120Vac

