



LED Optimized Drivers



PROGRAMMABLE
300W
LPF300W

300 Watt- LPF300W-NN-PCXXX-RD

FLICKER FREE PROGRAMMABLE LED DRIVER WITH 0-10V DIMMING & 12V AUX

Model: LPF300W Series

- Drive Mode: Flicker Free Programmable Constant Current
- Output Voltage: 55VDC, 200VDC or 457VDC
- Output Current: GUI Programmable
- Programmable Output Current (POC): See table below
- 0-10V Linear or LOG Dim Curves, Dimming 1% - 100%^(B)
- Dim to Zero? YES/NO setting, Standby Power $\leq 0.5W$.^(C)
- Soft Start? YES/NO setting.^(D)
- Auxiliary Output: 12V @ 200mA Max.

Environmental

1. Operating temperature: Tc 90C Maximum. Reference -40 to +50°C ambient
2. UL Listed, UL Class P, UL Type HL
3. Storage temperature range: -40 to +85°C
4. Humidity (non-condensing): 5% - 95%RH
5. Cooling: Convection
6. Vibration Frequency: 5-55Hz/2g, 30 minutes
7. Impact resistance: 1g/s
8. MTBF@ 25°C: 340,000 hours @ Full Load per MIL-HDBK-217F Notice 2.

Safety and Compliance

1. UL8750, EN61347, CSA22.2 listed, UL Class P, Type HL
2. FCC, 47CFR Part 15, 120Vac Class B, 277Vac Class A
3. Water resistant and Dust Proof Design: IP67, NEMA4, for Dry & Damp Locations.
4. Rectangular style aluminum case.
5. Safety Isolation between Primary, Secondary & 0-10V Dim
6. Meets EN61000-3-2 & EN61000-3-3 Class C
7. Protection: Output over-current, Output short circuit, Over Temperature, auto-recovery.
8. EN61000-4-5: 6kV/10kV 8/20 μ sec transient protection.

Electrical Specifications at 25°C

- Input voltage range: 120-277Vac (Full range 100 to 305Vac)
- Frequency: 47 - 63HZ
- THD%: $\leq 20\%$ at 120/230/277Vac $\geq 50\%$ Load
- Power Factor: ≥ 0.90 at 120/230/277Vac $\geq 50\%$ Load
- Inrush current: $\leq 118A$ at 25C, 120Vac, cold start, Max. Load
- Input current: 2.86A Maximum @ 120Vac
- Efficiency: 90% typical at 230Vac Full Load
- Constant Current regulation: $\pm 2\%$ Over Input Line Variation
- Load regulation accuracy: $\pm 3\%$
- Leakage current: 750uA Max. @ 277Vac

Programmable Parameters

-RD Set using EP-PRG-01 Programmer, -RDNFC Set using FEIG CPR30+ Programmer & EPtronics GUI Software.

Programmable Parameter	Programmable Minimum Value	Programmable Maximum Value	Factory Default	GUI Programmable
Output Constant Current (Iout) ^(A)	See Table	See Table	Maximum	YES
Disable Dimming?	NO	YES	NO	YES
Dimming Curves: LINEAR or LOG ^(B)	1% (Min Dim)	N/A Fixed 100%	LIN, 1% (Min Dim)	YES
Dim to Zero? ^(C)	NO	YES	NO	YES
Soft Start? ^(D)	NO	YES	NO	YES
NTC Minimum Ohms ⁽³⁾	1K Ω	10K Ω	2K Ω	YES
NTC Minimum %Iout ⁽³⁾	$\sim 0\%$	100%	$\sim 10\%$	YES
NTC Maximum Ohms ⁽³⁾	2K Ω	10K Ω	6.3K Ω	YES
Constant Lumen Output Lookup Table	1kHours/50% Iout	254k Hours/100%, Max 8 entry Lookup Table	Disabled	YES
End of Life Indicator	1k Hours	254k Hours	Disabled	YES

A. Output Current: Programmable Output Current (POC): Per table, Power limited to 300W by Voltage foldback.

B. Minimum Dimming current: If Dim to Zero = NO then Min Dim is 3mA or 1%, or % Set whichever is greater.

C. Dim to Zero?: If YES then will always dim to 0mA at Vdim $\leq 1.00V$ regardless of Min Dim% Setting.

D. Soft Start?: See page 8. NO, startup <500ms. YES, time to first light (100mA) <500ms, aesthetic fade on to 100% programmed Iout will be $\sim 3500ms$. Start-up time & Soft Start time are set to meet CA Title 24-2016.

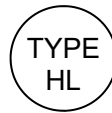

IP67



Programmable Constant Current Versions

Part Number ^{(1) (4)}	UL Types	Output Voltage Range	Output Constant Current ⁽²⁾	Current Accuracy	Output Power Maximum ⁽²⁾	Typical Efficiency ⁽¹⁾
LPF300W-55-PC6700-RD	Class P, Type HL	10 - 55 VDC	1000 mA to 6700 mA	$\pm 5\%$	300W	90%
LPF300W-100-PC4300-RD	Class P, Type HL	20 - 100 VDC	700 mA to 4300 mA	$\pm 5\%$	300W	90%
LPF300W-200-PC3000-RD	Class P, Type HL	36 - 200 VDC	500 mA to 3000 mA	$\pm 5\%$	300W	90%
LPF300W-457-PC1400-RD	Class P, Type HL	83 - 457 VDC	200 mA to 1400 mA	$\pm 5\%$	300W	91%

- Notes:**
1. Typical efficiency measured at 230VAC input, Iout full load
 2. Keep POC (Programmable Output Current) within 75W Maximum Power Operating Window. Refer to Power Operating Window graph on page 8. Part will foldback output current to maintain power limit.
 3. NTC Minimum value set must not exceed 70% of Maximum value set. See page 9 for NTC graph.
 4. Wireless Programming Version add NFC at end of part number. i.e. -RDNFC = Wireless Programming, -RD = wired programming

Custom designs available. Please consult with the factory.

Specifications subject to change without notice

300W
LPF300W

PROGRAMMABLE



LED Optimized Drivers

300 Watt- LPF300W-NN-PCXXXX-RD

FLICKER FREE PROGRAMMABLE LED DRIVER WITH 0-10V DIMMING & 12V AUX

-RD: Wire Programmable Version with NTC

Mechanical Dimensions: Inches [mm]

Material: Clear Anodized Aluminum Housing Fully Encapsulated
Weight: 57.5 oz (1630 grams) Typical
Case must be grounded in end use application.

Labeling Example

 Programmable LED Driver EPtronics, Inc. www.EPtronics.com 800 643-0688/310 535-9700	Part Number: LPF300W-55-PC6700-RD Input Voltage: 120-277VAC 50/60Hz Input Current: 4.00 Amp Max Output Voltage: 10-55 VDC , 300W Max Output Current (POC): 1000-6700 mA (Default 6700mA) Programmable via NTC (P+) Wire UL & cUL Class 2 0-10V OCR Programmable Dimming Isolated Class 2 Dim suitable for Class 1 or Class 2 circuit UL Type HL, Suitable for use in Dry & Damp Locations UL Class P, For Connections use wire rated \geq 90C (194F)	DC OUTPUT LED+ = RED LED- = BLUE 12V OUTPUT & GND/NTC 12V@200mA = YELLOW SCOM (P-) = BLACK NTC (P+) = BROWN 0-10V DIMMING DIM+ = VIOLET DIM- = PINK
	 YG Made in China REV. A	

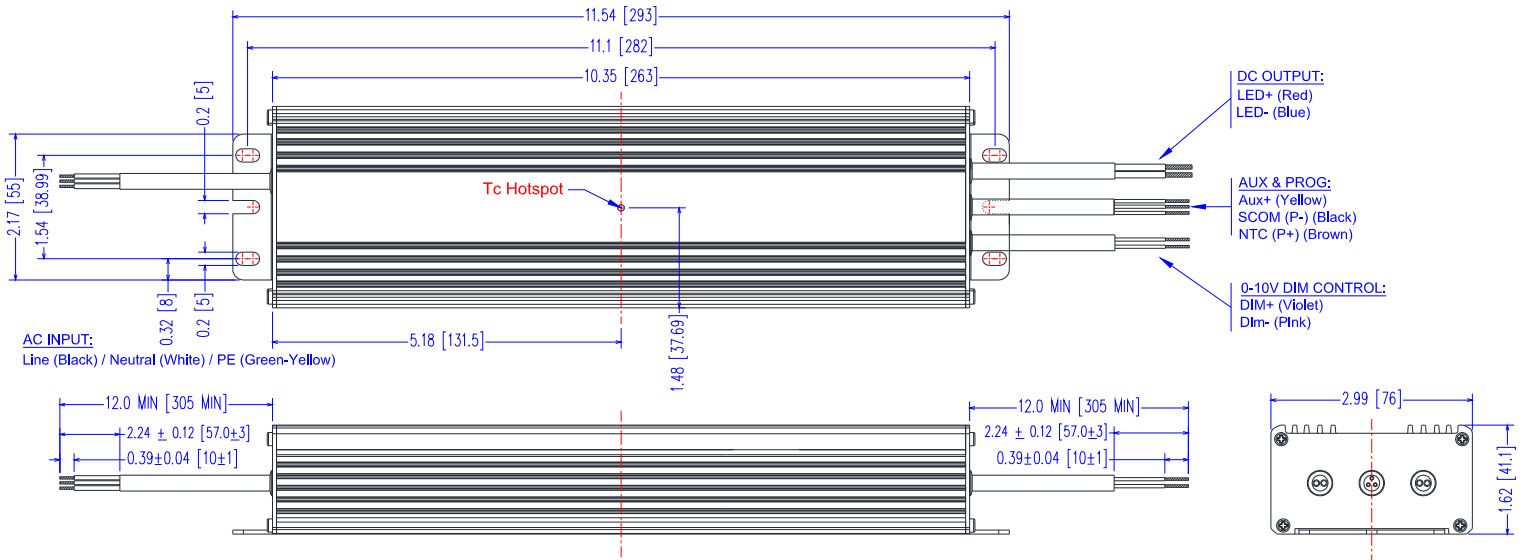

Case Parameter	Inches [mm]
Length	11.54 [293]
Width	2.99 [76.0]
Height	1.62 [41.1]
Nominal Mount Dimensions	11.10 [282] L x 2.17 [55] W

LED wiring distance:

Recommended maximum wiring distance:
44.76V@6700mA with ~5% Vout Drop.

AWG	#22	#21	#20	#19	#18	#16
Distance (m)	3.2	4.0	5.0	6.3	8.0	12.7
Distance (ft)	10.3	13.0	16.5	20.7	26.2	41.6

Custom designs available. Please consult with the factory.

300 Watt- LPF300W-NN-PCXXX-RD

FLICKER FREE PROGRAMMABLE LED DRIVER WITH 0-10V DIMMING & 12V AUX

-RDNFC: NFC Wireless Programmable Version with NTC

Mechanical Dimensions: Inches [mm]

Material: Clear Anodized Aluminum Housing Fully Encapsulated
Weight: ??? oz (??? grams) Typical
Case must be grounded in end use application.

Labeling Example

	Programmable LED Driver EPtronics, Inc. www.EPtronics.com 800 643-0688 / 610 526-0700	Part Number: LPF300W-55-PC6700-RDNFC Input Voltage: 120-277VAC 50/60Hz Input Current: 4.00 Amp Max Output Voltage: 10-55 VDC, 300W Max Output Current (POC): 1000-6700 mA (Default 6700mA) NFC Programmable UL & cUL Class 2 0-10V GCR Programmable Dimming Isolated Class 2 Dim suitable for Class 1 or Class 2 circuit UL Type HL, Suitable for use in Dry & Damp Locations UL Class P, For Connections use wire gauge ≥ 90C (194F)	DC OUTPUT LED+ = RED LED- = BLUE 12V OUTPUT & NTC 12V@200mA = YELLOW SCOM = BLACK NTC = BROWN 0-10V DIMMING DIM+ = VIOLET DIM- = PINK
		YG Made in China REV. A	

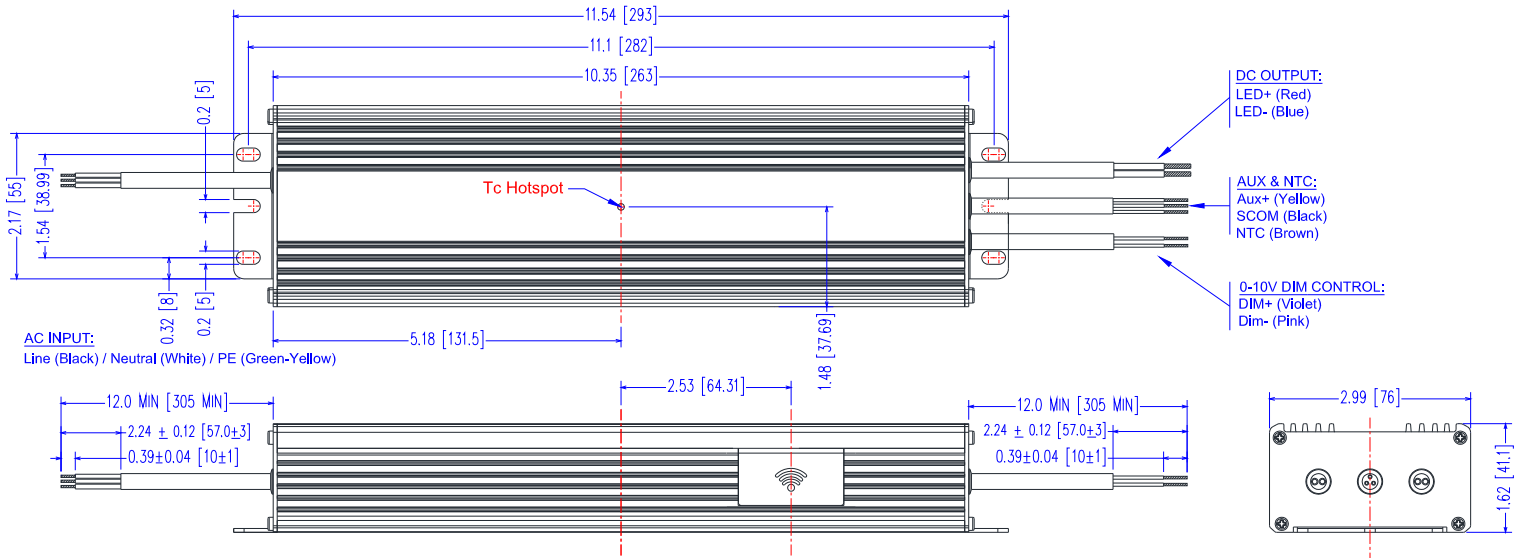

Case Parameter	Inches [mm]
Length	11.54 [293]
Width	2.99 [76.0]
Height	1.62 [41.1]
Nominal Mount Dimensions	11.10 [282] L x 2.17 [55] W

LED wiring distance:

Recommended maximum wiring distance:
44.76V@6700mA with ~5% Vout Drop.

AWG	#22	#21	#20	#19	#18	#16
Distance (m)	3.2	4.0	5.0	6.3	8.0	12.7
Distance (ft)	10.3	13.0	16.5	20.7	26.2	41.6

300 Watt- LPF300W-NN-PCXXXX-RD

FLICKER FREE PROGRAMMABLE LED DRIVER WITH 0-10V DIMMING & 12V AUX

-RD, 0-10V & Resistance Dimming Scheme

Parameters	Minimum	Typical	Maximum
12V Auxiliary Output	11V	12.0V	13.0V
12V Auxiliary Output Source Current	0mA	—	200mA
Absolute Voltage Range on 0-10V Input (VIOLET Wire)	-2.0V	—	+15V
Source Current out of 0-10V Input (VIOLET Wire)	0uA	—	250uA

Notes

1. Part comes with 12V auxiliary & 12VCOM. 12V return is connected to 12VCOM. Isolated DIM+, DIM-.
2. Part is compatible with most 0-10V Wall Slide dimmers and direct 0-10V analog signal. Recommended dimmer is Leviton IP710 or equivalent connected between DIM+, VIOLET and DIM- PINK wires.
3. Output will be 100% with DIM+/DIM- open and Minimum Programmed Value, or OFF with DIM+/DIM- Shorted.
4. Minimum dimming level & Dim to Zero? are programmable with EPtronics LED Driver Interface Programming Tool.

-RD 2-Wire Resistance Dimming Scheme

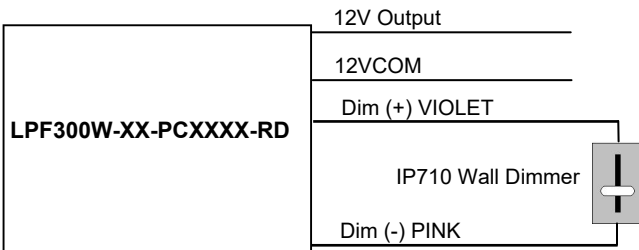

-RD 2-Wire 0-10V Dimming Scheme

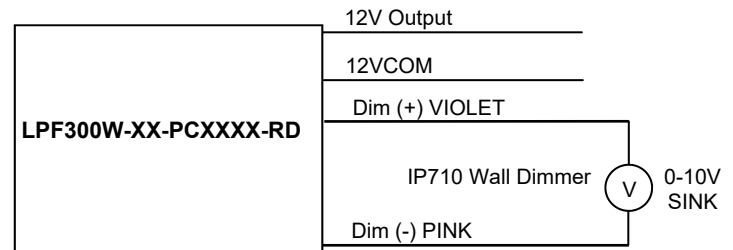

Typical Dimming Curves: Dim to Zero? = YES

% Output Current Vs. 0-10V DC Dimming Input

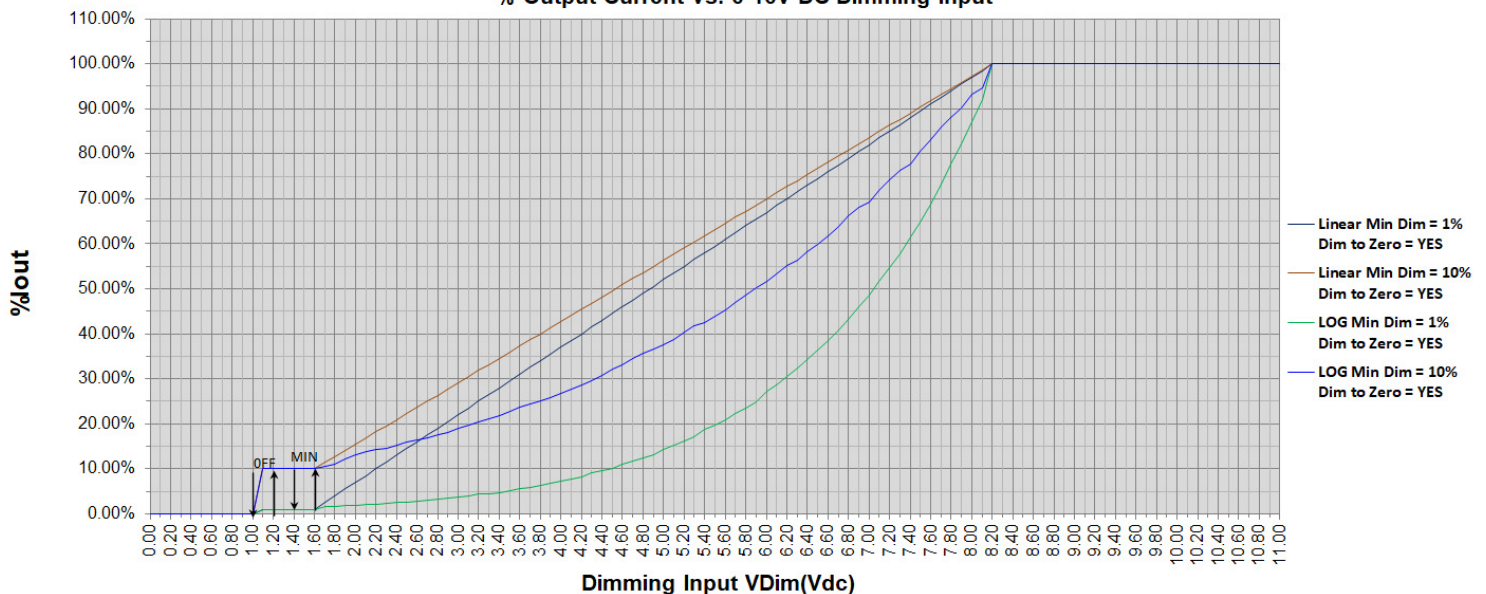

300 Watt- LPF300W-NN-PCXXX-RD

FLICKER FREE PROGRAMMABLE LED DRIVER WITH 0-10V DIMMING & 12V AUX

Input Specifications

Parameter	Min.	Typ.	Max.	Notes/Conditions
Input Voltage	100 Vac	—	305 Vac	120, 230, 240, 277 Vac Nominal Values
Input Frequency	47 Hz	—	63 Hz	50/60Hz Nominal
Input AC Current	—	—	2.86 A	Measured at 120Vac/60Hz Input, Output Full load.
	—	—	1.35 A	Measured at 277Vac/60Hz Input, Output Full load.
Inrush Current (Peak) Ipk 10%Pw ≤360usec	—	—	118 A	Measured at 120Vac/60Hz Input, Output Full Load, Ta 25°C, Cold Start
	—	—	255 A	Measured at 277Vac/60Hz Input, Output Full Load, Ta 25°C, Cold Start
Leakage Current	—	—	0.50 mA	Measured at 120Vac/60Hz Input, Output Full load.
	—	—	0.75 mA	Measured at 277Vac/60Hz Input, Output Full load.
THD	—	—	20%	Measured at 120/230/277Vac ≥ 50% Load
Power Factor (PF)	0.90	—	—	Measured at 120/230/277Vac ≥ 50% Load
Standby Power (Dim to Zero)	—	—	0.5W	Measured at 120/230/277Vac, Dimmed to Zero (Vdim ≤0.9V)

Output Specifications

Parameter	Min.	Typ.	Max.	Notes/Conditions
DC Output Voltage	Per Table	—	Per Table	Per Table on Page 1
DC Output Current (POC)	-5%	Per Table	+5%	Programmable Output Current (POC) POC is set using GUI
Output Power	—	—	300W	Voltage Foldback, See graph on page 8
Ripple & Noise (Vpk-pk)	—	—	3% Vo	20 MHz BW, Full load output in parallel with 0.1 μF ceramic & 10 μF Electrolytic.
Ripple (Ipk-pk)	—	—	5% Io	20 MHz BW, Full load output in parallel with 0.1 μF ceramic & 10 μF Electrolytic. 120 Hz component (Flicker Free)
Start-up Time	—	—	500 mS	Measured at 98% of Iout, 120Vac/60Hz Input, Output Full Load.
Hold-up Time	—	30 mS	—	Typical @ 277Vac Input, Output Full load.
Auxiliary Output (V)	11	12	13	@ 200mA Maximum

Environmental Specifications

Parameter	Min.	Typ.	Max.	Notes/Conditions
Case Temperature (Tc)	-40 °C	—	+90 °C	Measured at location specified on case.
Operating Temperature (Ta)	-40 °C	—	+50 °C	This is a reference range. Tc controls temperature range.
Storage Temperature (Ts)	-40 °C	—	+85 °C	Non operating temperature range.
Operating Humidity	—	—	95% RH	Relative Humidity, non-condensing.
Vibration	5 Hz	—	55 Hz	2G, 10 minutes/1 cycle, period 30 minutes, each along X, Y, Z axis.
MTBF	—	340,000 Hours	—	MIL-HDBK-217F Notice 2, Ta = 25C, Output Full Load.

Protection Specifications

Parameter	Min.	Typ.	Max.	Notes/Conditions
Output Short Circuit (SCP)	—	—	—	No Damage, Auto recovery after short is removed.
Output Over Current (OCP)	—	—	+10% Io	Constant Current Limiting circuit.
Output Over Voltage (OVP)	—	—	+7% Vo	No Damage, Requires AC Power Cycle after fault is removed.
Output Power Limit (OPL)	—	—	300W	Current Foldback
Over Temp Protection (OTP)	95 °C	—	100 °C	Foldback at Tc ≥95C, 1% Iout @ Tc ~110C

300 Watt- LPF300W-NN-PCXXXX-RD

FLICKER FREE PROGRAMMABLE LED DRIVER WITH 0-10V DIMMING & 12V AUX

Safety Compliance

Safety	Notes/Standards
UL/CUL Listed UL Class P	UL8750 & CAN/CSA C22.2 No. 250.13, UL Class P, UL Type HL
CE	EN61347-1, EN61347-2-13, EN62493
Dielectric Withstand Voltage	Input to Output & Dimming: 3750 Vac (CE, ENEC covers UL 2000V requirement)
	Dimming to Output: 2500 Vac
Isolation Resistance	Input to Output: >100 MΩ, 500VDC @ 25 °C, 70 % RH
0-10V Class 2 Isolated Dimming Circuit	Dim+ VIOLET/Dim- PINK are Class 2 Isolated from all other inputs & outputs. 0-10VDC Dimming suitable for Class 1 or Class 2 circuit.
FG	The metal case of the driver must be connected to earth ground (FG) in the end-use application.
Sound Rating	<24dB Class A @ 1 Meter

EMC Compliance

Standard	Notes/Conditions
FCC, 47 CFR Part 15 ANSI C63.4	Class B @120Vac, Class A @ 277Vac
EN 55015	Limits and methods of measurement of radio disturbance characteristics of electrical lighting and similar equipment.
EN 61000-3-2	Part 3-2: Limits for harmonic current emissions Class C, $\geq 80\%$ Rated Power
EN 61000-3-3	Part 3-3: Limitation of voltage changes, voltage fluctuations and flicker.
EN 61000-4-5	Part 4-5: Surge Immunity test, 6 kV L-N, 10 kV L-FG & N-FG
Energy Star	Energy Star transient protection: Ballast or driver shall comply with ANSI/IEEE C62.41.1-2002 and ANSI/IEEE C62.41.2-2002, Category A operation. The line transient shall consist of seven strikes of a 100 kHz ring wave, 2.5 kV level, for both common mode and differential mode.

Power Factor Curves (Typical)

PF vs. Output Power

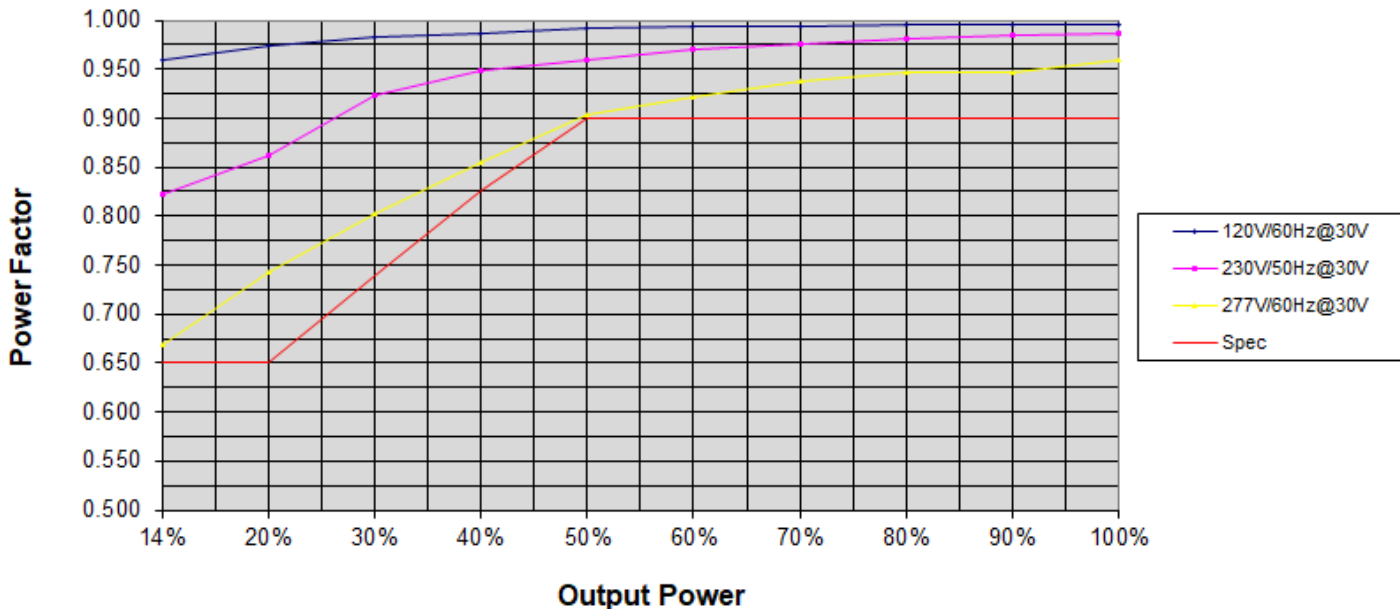

300 Watt- LPF300W-NN-PCXXX-RD

FLICKER FREE PROGRAMMABLE LED DRIVER WITH 0-10V DIMMING & 12V AUX

THD Curves (Typical)

THD vs. Output Power

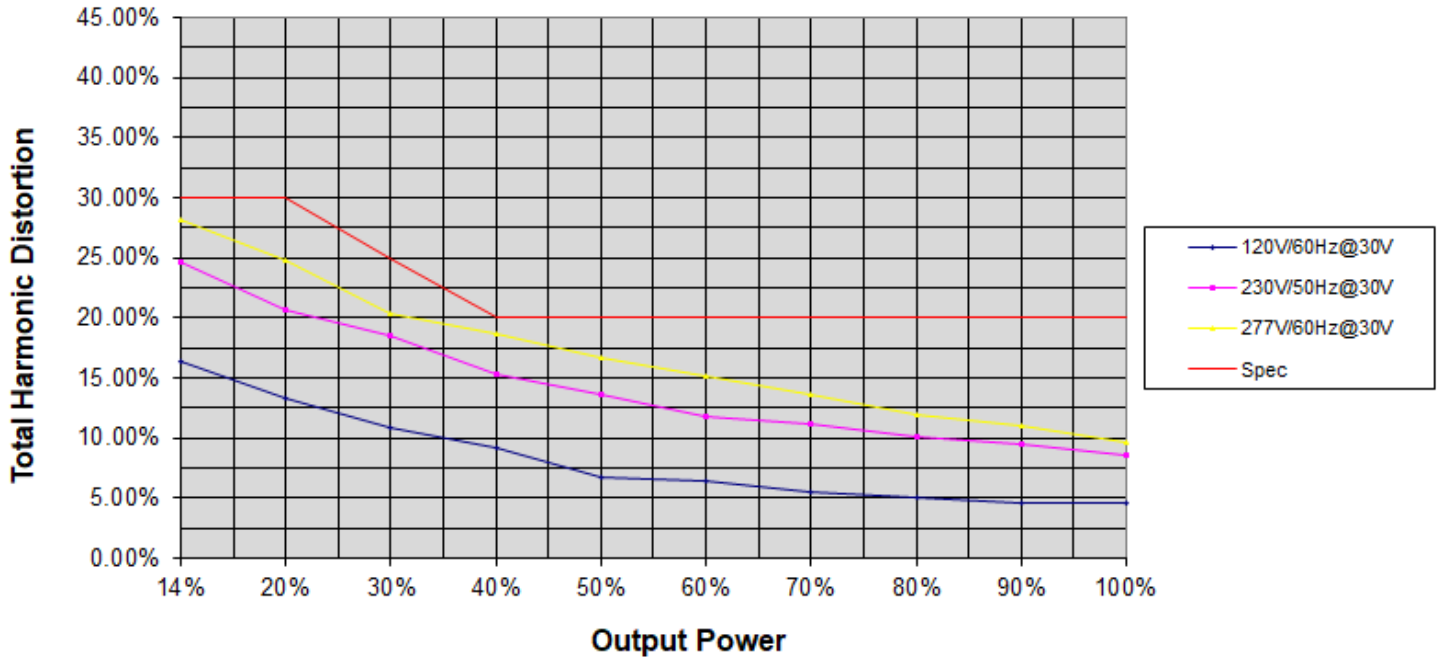

Efficiency Curves (Typical)

Efficiency vs. Output Power

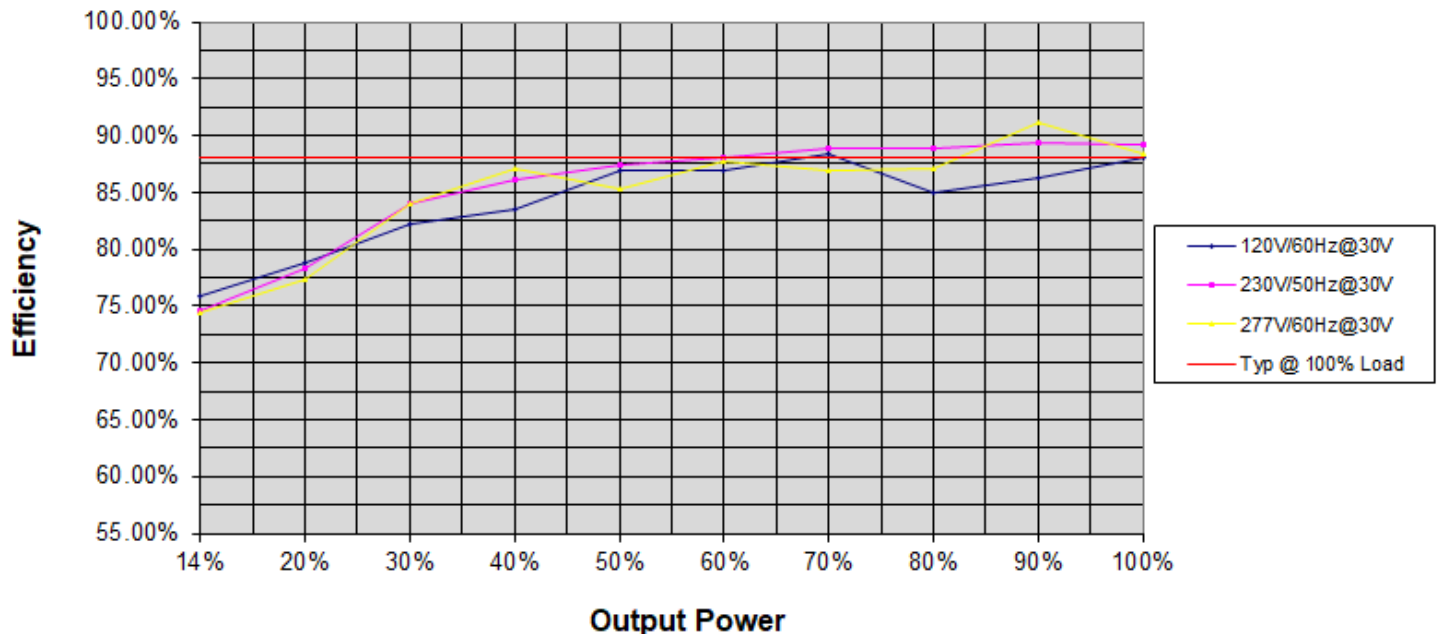

300 Watt- LPF300W-NN-PCXXXX-RD

FLICKER FREE PROGRAMMABLE LED DRIVER WITH 0-10V DIMMING & 12V AUX

Power Operating Windows

LPF300W-55-PC6700-RD OPERATING WINDOW
Vout (Vdc) vs. Output Current (mA)

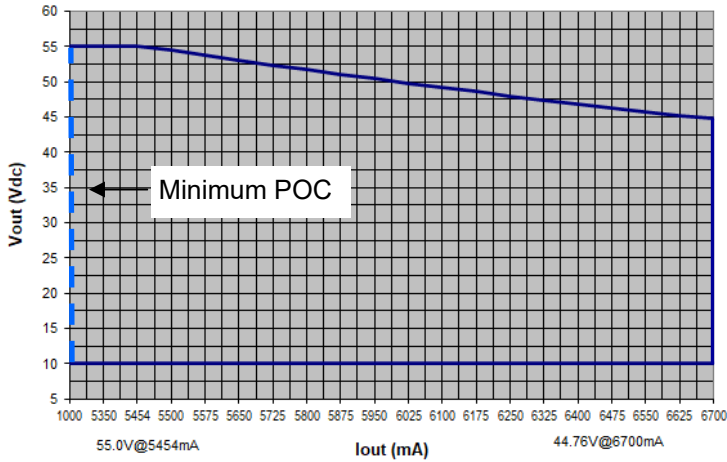

LPF300W-200-PC2800-RD OPERATING WINDOW
Vout (Vdc) vs. Output Current (mA)

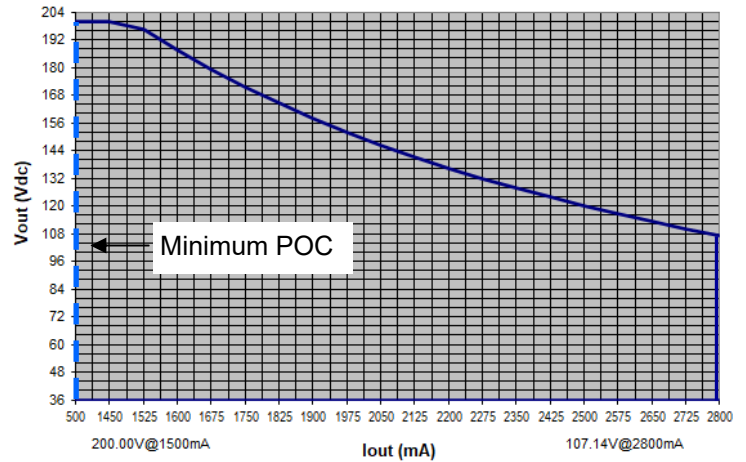

LPF300W-457-PC1400-RD OPERATING WINDOW
Vout (Vdc) vs. Output Current (mA)

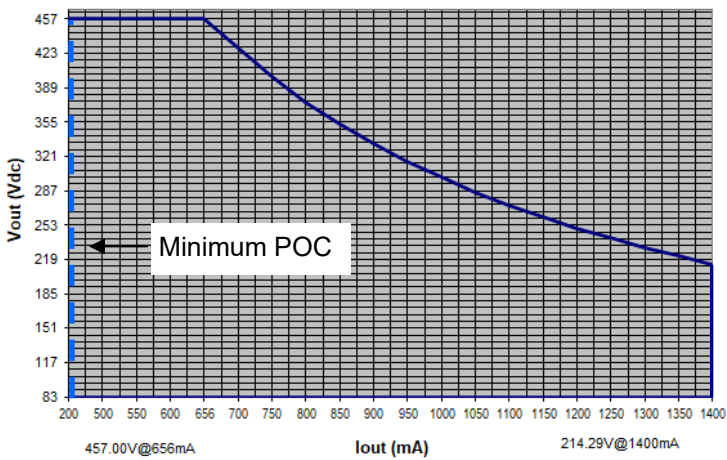

Soft Start Operation:

Specification: Time-To-First-Light (100mA) <500ms, Time to 90% Iout ~ 3 Seconds, Time to 100% Iout <4.0 Seconds

Example Soft Start Time vs Programmed Output Current

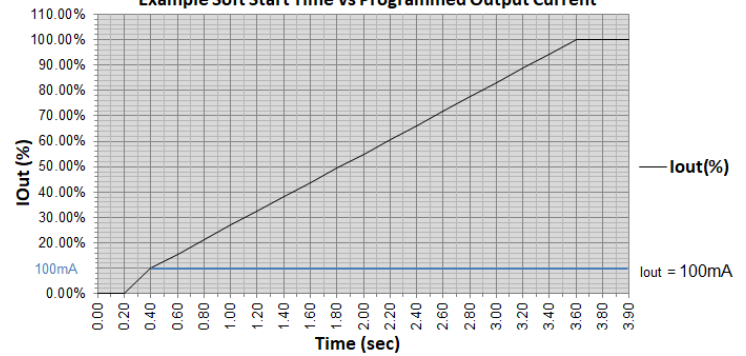

300 Watt- LPF300W-NN-PCXXX-RD

FLICKER FREE PROGRAMMABLE LED DRIVER WITH 0-10V DIMMING & 12V AUX

-RD Version Temperature Protection using External NTC

Example: NTC High, NTC Low and NTC Minimum Iout% can be programmed using EP Programmer USB interface & EPtronics PC based GUI Software.

Factory Default Settings: NTC Low = 2.0K \approx 10% Iout, NTC High = 6.3K, 100% Iout

Programmable settings: NTC Minimum Level (%), NTC Minimum Ohms, NTC Maximum Ohms.

Output Current (%) vs. NTC (Ohms)

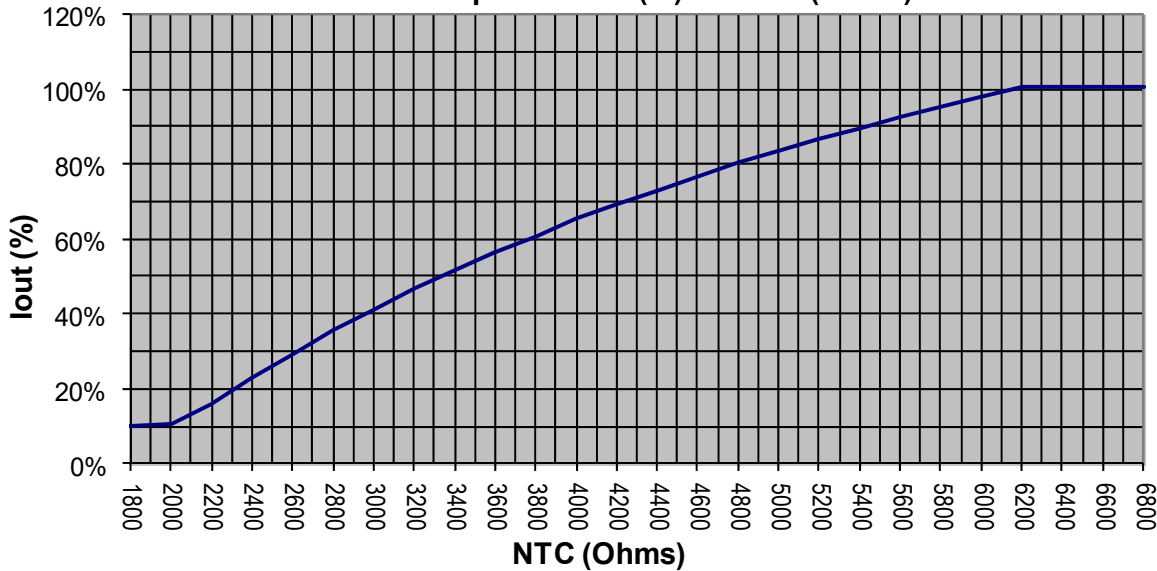

-RD Version Temperature Protection Example

NTC = 805SMD, $R_{25C} = 15K \text{ Ohm} \pm 2\%$, $R_{64C} = 3700$, Vishay Part#: NTCS0805E3153GMT

With part set: NTC Max = 6.3K, NTC MIN = 2.0K, Iout Min = 10%

Output Current (%) vs. NTCS0805E3153GMT NTC Temp ($^{\circ}C$)

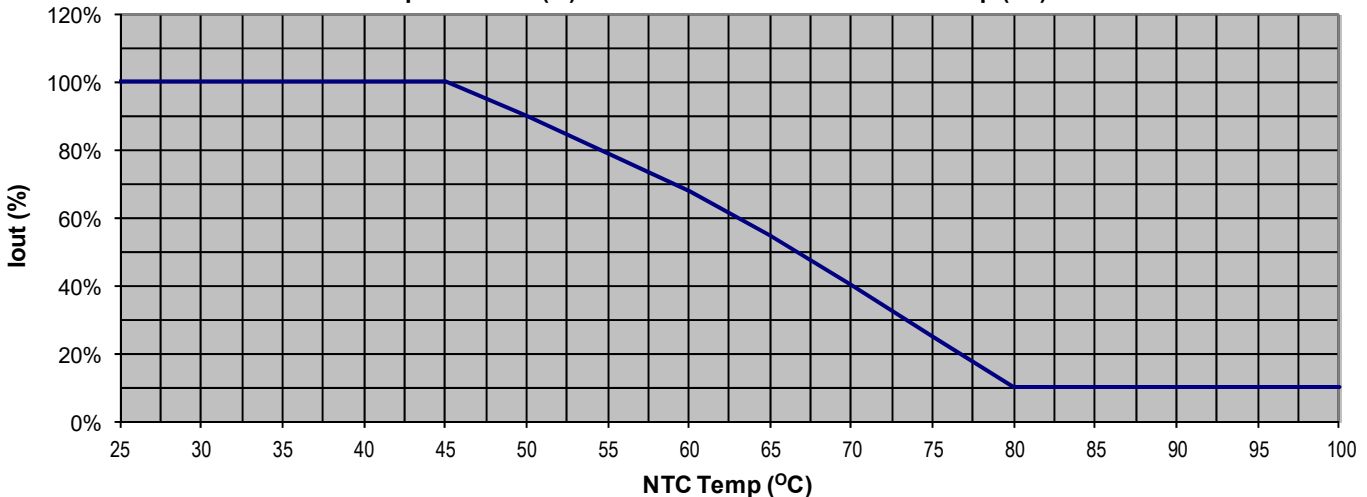

300W
LPF300W

PROGRAMMABLE



LED Optimized Drivers

300 Watt- LPF300W-NN-PCXXXX-RD

FLICKER FREE PROGRAMMABLE LED DRIVER WITH 0-10V DIMMING & 12V AUX

EPtronics LED Driver Interface Programming Tool: PC Based Software

Programmable Output Current (POC): Programmable Iout Per table page 1

Programmable NTC settings: NTC Minimum Level (%), NTC Minimum Ohms, NTC Maximum Ohms.

Factory Default: NTC Minimum = 2.0K, \approx 10% Iout, NTC Maximum = 6.3K, 100% Iout

Programmable dimming curve: Linear or LOG

Factory Default: Linear Dimming Curve

Programmable Minimum Dim Level: 1% (Min Dim) to 100% Iout programmed value.

Factory Default: Min dim level 1% (Actual Min Dim per specifications)

Programmable Dim to Zero?: YES or NO. YES will cause 0mA at \leq 1.0V, else will be Minimum Dim Level.

Factory Default: NO

EPtronics LED Driver Interface Programming Tool:

The EPtronics LED Driver Interface Programming Tool is a programming and configuration tool for EPtronics intelligent programmable LED drivers. It consists of the EP Programming Interface (EP-PRG-01) which is connected between the USB port of a computer and the LED driver being programmed, and the EPtronics LED Driver Interface Programming Tool software. The EPtronics LED Driver Interface Programming Tool software is a PC based graphical user interface that allows the user to program and configure the operating parameters of an EPtronics Programmable LED Driver. This interface allows the operator to set the LED drivers output current within its specified range, in the increments specified. It also provides the ability to enable/disable and control features like "Dimming", "Auxiliary Output", "NTC Thermal Protection", "Constant Lumen Module" & "End-of-life indicator" when available in the EPtronics intelligent LED driver being programmed.

EP Programming Interface: (EP-PRG-01 Wired or EP-PRG-NFC for wireless)

is the physical USB unit connected between the USB port of a computer and the LED driver being programmed. This unit also provides all power required to the LED driver being programmed. No connection to an AC power source is required for programming the LED driver.

EPtronics LED Driver Interface Programming Software:

The EPtronics LED Driver Interface Programming software is the windows based GUI that allows the user to assign custom part numbers to the LED driver being programmed. The user can then save the profile to a computer disk and recall as needed. The user can then use the "Auto Program" feature to quickly program as many LED drivers with the saved profile as is required. Each driver programming simply requires a click of the mouse to program in a single step or the use of an EPtronics Programming Cradle which will auto program upon insertion the an LED driver into the cradle.

The EPtronics LED Driver Interface Programming software supports bar code scanners. The barcode scanner can be used to automate the programming of the attached LED driver. This barcode scanner interface also provides an option to either enable or disable logging of the parameters to an excel file.

Note: The programming of the LED driver does not require the input be connected to an AC power connection. The EP Programming Interface and the required LED driver circuitry will be powered from the EP-PRG-XXX module via the USB connection to a computer. For new GUI settings to take effect the AC input must cycled off/on and the USB interface disconnected.

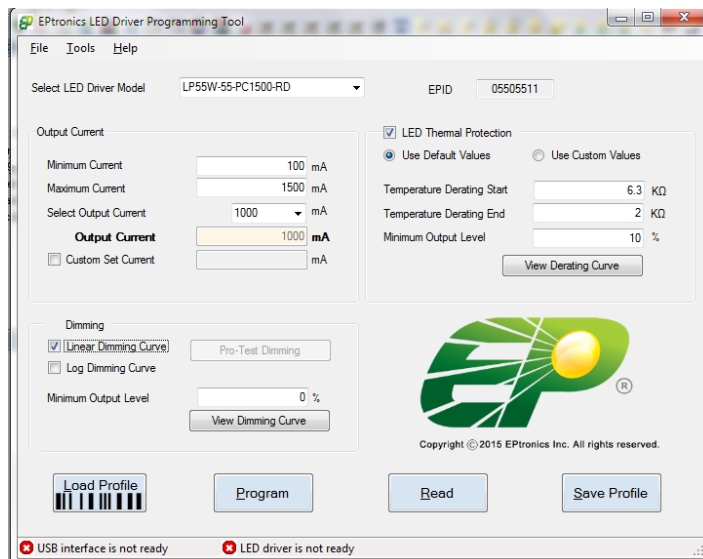

300 Watt- LPF300W-NN-PCXXX-RD

FLICKER FREE PROGRAMMABLE LED DRIVER WITH 0-10V DIMMING & 12V AUX

Life vs. Ambient Temperature

LPF300W-XX-PCXXX-RD Estimated Life Full Load @ 120Vac

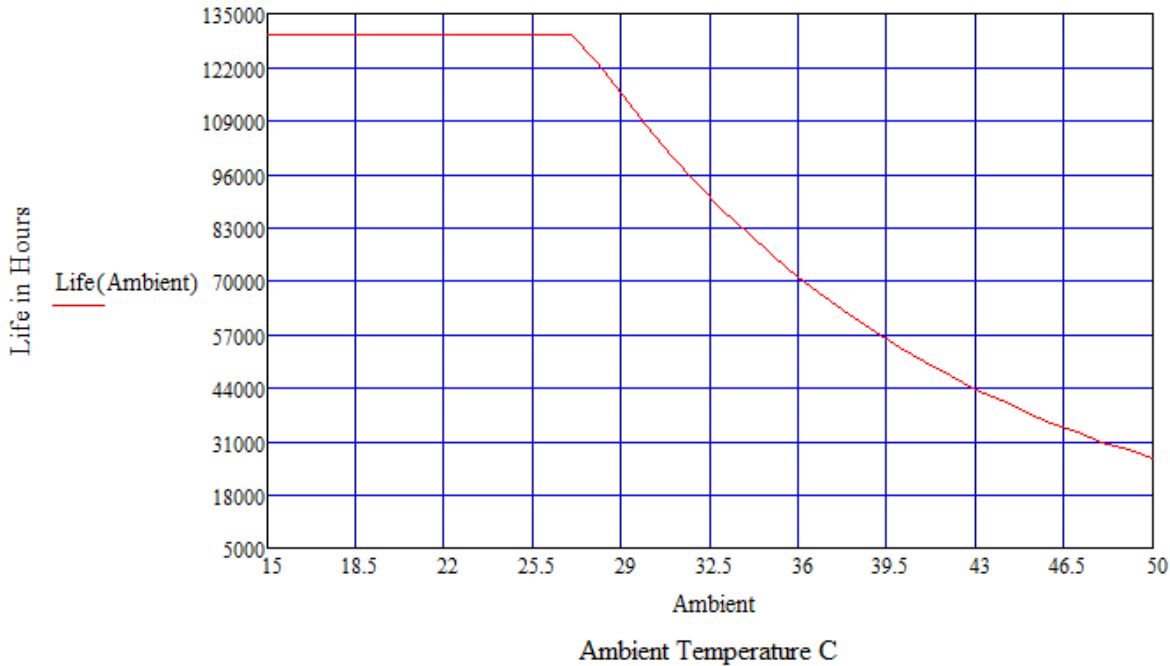

Life vs. Case (Tc) Temperature

LPF300W-XX-PCXXX-RD Estimated Life Full Load @ 120Vac

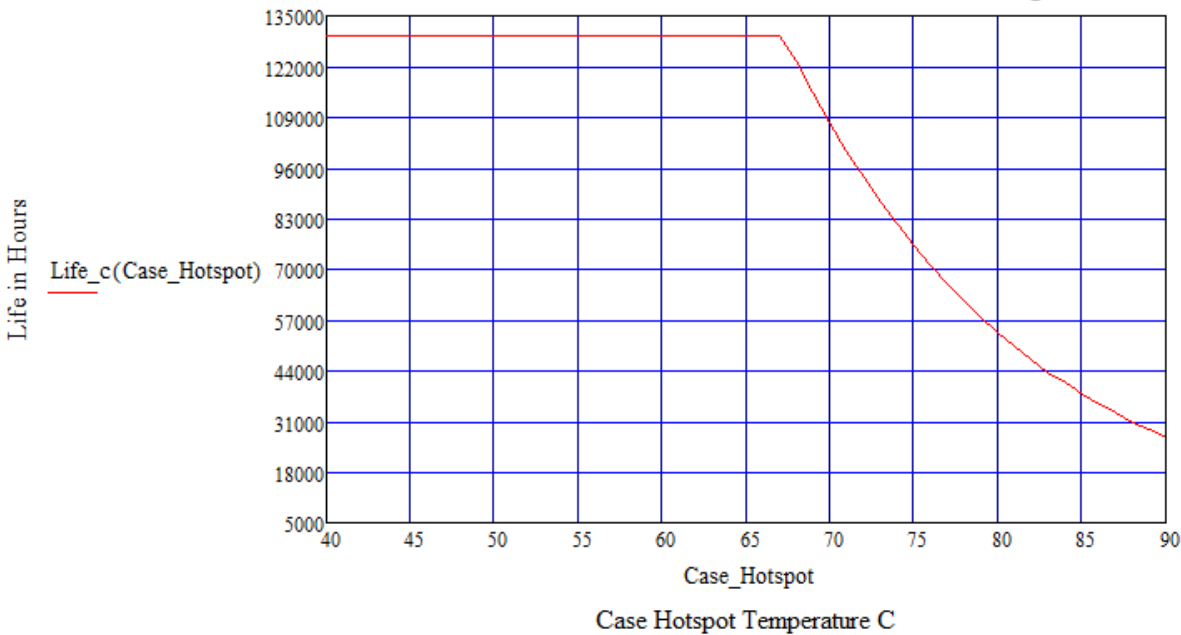

300W
LPF300W

PROGRAMMABLE



LED Optimized Drivers

300 Watt- LPF300W-NN-PCXXXX-RD

FLICKER FREE PROGRAMMABLE LED DRIVER WITH 0-10V DIMMING & 12V AUX

Revision History

REV - Change Date	Description of Changes		
	Items	Changed From	Changed To
REV A - 10/20/2020	Initial spec release	N/A	N/A
REV A - 06/18/2021	DIM Wire Colors	PURPLE/GRAY	VIOLET/PINK, per NEMA 100
REV A - 01/12/2023	Soft Start	Soft Start Time to first light value 400mA	Soft Start Time to first light value. changed to 100mA